

MODEL PORTI-W40

(4inch Mobile Printer)

Rev. 3.1

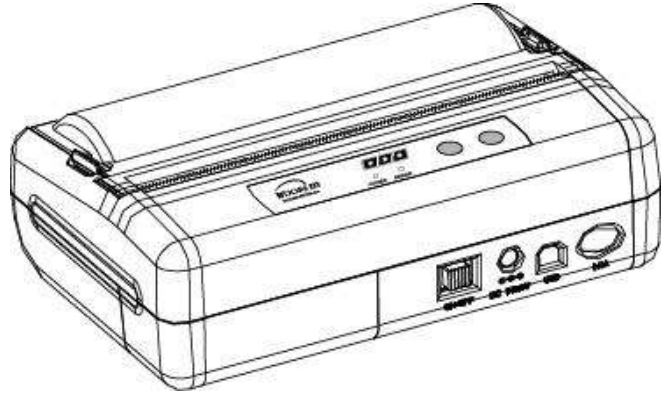

UTING®
ELEKTRONIK

Türkiye Genel Dağıtım:
Uting Elektronik ve Endüstriyel Ürünler, Mümessillik,
Dış Ticaret ve San. Ltd.Şti.

www.utingelektronik.com

Tel: 0212- 639 20 95,-96,-97 Fax: 0212- 639 32 19

All specifications are subjected to change without notice.

■ Copyright

PORTI-W40 4inch mobile printer operator's manual.

Copyright ©2018 by Woosim Systems Inc.

All rights reserved.

The information contained in this manual is the property of Woosim Systems Inc.

And may not be reproduced in whole or in part without the prior written permission of Woosim Systems Inc.

■ Trademark



Woosim a registered trademark of Woosim Systems Inc.

All other trademark are the properties of their respective companies.

■ Caution

Some semiconductor devices are easily damaged by static electricity. You should turn the printer "OFF", before you connect or removed the cable on the rear side, in order to guard the printer against the static electricity.

If the printer is damaged by the static electricity, you should turn the printer "OFF".

■ Notice

The contents of this manual are subject to change without notice.

■ Introduction

The **PORTI-W40** is the ideal solution for Mobile banking system , Retail, point of sales, Credit card Transaction, other traveling and mobile computing etc.

The general features of **PORTI-W40** printer are as follows:

- ▶ Compact size (138.4 x 88.5 x 45.2mm)
- ▶ Light weight (281g) for true mobility.
- ▶ Very silent printing thru direct thermal printing method.
- ▶ High speed(50mm/sec, MAX)
- ▶ High resolution(203dpi : 8dots/mm)
- ▶ UART(RS-232C or TTL), USB(option), Bluetooth Ver3.0 Interface
- ▶ Intuitive LED's indicate Power(on/off), Error, Battery status
- ▶ Support text and graphic printing.
- ▶ Easier paper loading by CLAMSHELL design.
- ▶ One touch paper cover
- ▶ Printer door open & Paper-out sensor
- ▶ Easier maintenance with self-diagnostics.
- ▶ In field programming – Update Firmware, Download Fonts and Logos
- ▶ Microsoft Windows/Windows CE, Linux, Android, iOS compatible
- ▶ Flow control : Software (XON/XOFF)
 - ※ Hardware flow control not supported in printer.
- ▶ Agency Approvals



■ Operating Precautions

Please follow the precautions below to enjoy and maintain the full performance of the printer.

▶ Using the Printer

- Be careful not to drop or bump the printer on a hard surface.
- Do not install the printer in direct sunlight or such areas.

Suitable environment for the use of the printer is as follows:

- ◆ Operating temperature: -10°C to 50°C
- ◆ Relative humidity : 30% to 80%
- Do not install the printer near devices that generate strong electromagnetic fields such as a copy machine.
- Do not open the platen cover during printing .
- Do not remove or reinstall the communication cable during printing or transmission.
- Do not touch the connectors of the communication during printing.
- Switch the POWER OFF when not in use.
- Do not use other solvent.
- The AC adapter, the battery charger and the battery pack may become warm when in use. This is normal and is not a malfunction.
- When the battery pack is used at low temperature, the length of time the printer can be used may be shortened.

▶ Thermal Paper Handling

- Store the thermal paper in a cool, dry and dark place.
- Do not rub the paper with hard object.
- Do not leave the paper with hard object.
- Do not allow plastic film, erasers, or adhesive tape to touch the paper for long periods.
- Do not stack the thermal paper with diazo copies immediately after copying or wet-type copies.
- Do not use chemical glue.
- Always use the clean thermal paper.

**Federal Communications Commission
Radio Frequency Interference Statement**

FCC ID : QDDPORTI-W40

This device complies with Part 15 of the FCC Rules. Operation is subject to the following two conditions:
(1) This device may not cause harmful interference, and (2) this device must accept any interference received, including interference that may cause undesired operation.

CAUTION: Changes or modifications not expressly approved by the party responsible for compliance could void the user's authority to operate the equipment.

Note: This equipment has been tested and found to comply with the limits for a Class B digital device, pursuant to part 15 of the FCC Rules. These limits are designed to provide reasonable protection against harmful interference in a residential installation. This equipment generates, uses and can radiate radio frequency energy and, if not installed and used in accordance with the instructions, may cause harmful interference to radio communications. However, there is no guarantee that interference will not occur in a particular installation. If this equipment does cause harmful interference to radio or television reception, which can be determined by turning the equipment off and on, the user is encouraged to try to correct the interference by one or more of the following measures:

- Reorient or relocate the receiving antenna.
- Increase the separation between the equipment and receiver.
- Connect the equipment into an outlet on a circuit different from that to which the receiver is connected.
- Consult the dealer or an experienced radio/TV technician for help.

Modifications not expressly approved by the manufacturer could void the user's authority to operated the equipment under FCC rules.

This Device has been evaluated to comply with RF exposure requirement for general use limit in portable condition. It is safe to be used in sold condition.

CE WARNING

- Changes and modifications not expressly approved by the party responsible for compliance could void the user's authority to operate the equipment.
- It is desirable that it be installed and operated with at least 20cm or more between the radiator and person's body(excluding extremities hand, wrists, feet, and ankles)

CONTENTS



- 1. Outline 7**
 - 1.1. Model classifications 7
 - 1.2 Symbol 7
 - 1.3. Product Part Number System..... 8
 - 1.4. Specifications..... 9
- 2. Setting up the printer.....10**
 - 2.1. Printer & Accessories10
 - 2.2. Printer Features11
 - 2.2.1. Part name11
 - 2.2.2. Dimensions11
 - 2.4. Replacing the paper roll12
 - 2.5. Power supply.....13
 - 2.5.1. Internal power supply13
 - 2.5.2. Installing the Battery13
 - 2.5.3. Recharging the battery14
 - 2.6. Set operation mode15
- 3. Interface.....18**
 - 3.1. UART(RS-232C or TTL) or USB18
 - 3.2. Bluetooth18
- 4. Using the printer.....19**
 - 4.1. Control panel.....19
 - 4.2. The self test.....19
- 5. Consumable Parts.....20**
 - 5.1. Recommended paper20
 - 5.2. Printing position20
- 6. Revision History21**

1. Outline

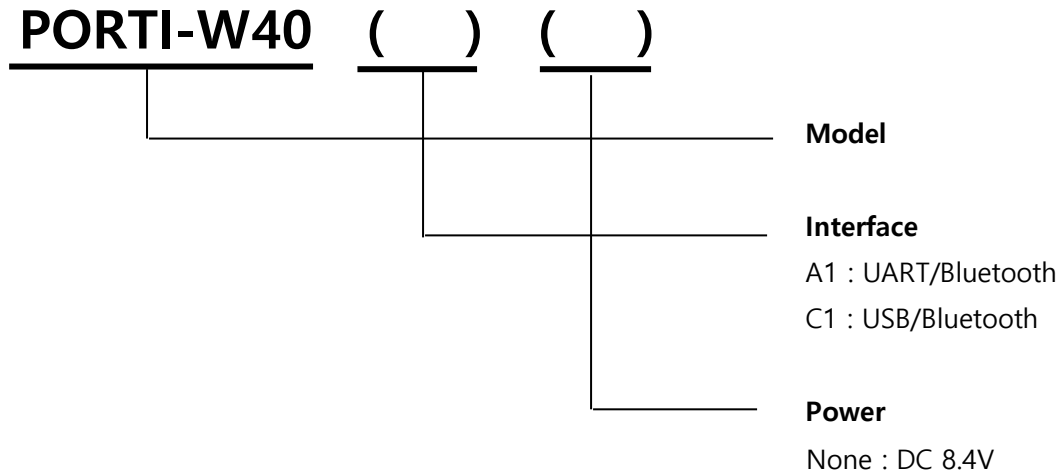
1.1. Model classifications



1.2 Symbol

	<p>Standby symbol</p> <p>IEC 5009, the standby symbol(line partially within a broken circle), Indicates a sleep mode or low power state.</p>
	<p>Direct current symbol</p> <p>This symbol is found on many electronic devices that either require or produce direct current.</p>

1.3. Product Part Number System

Model name		Interface Spec.																																	
<table border="1" style="width: 100%; height: 100%; border-collapse: collapse;"> <tr><td>S40</td></tr> <tr><td>SC30</td></tr> <tr><td>W25</td></tr> <tr><td>.</td></tr> <tr><td>.</td></tr> <tr><td>.</td></tr> </table>	S40	SC30	W25	.	.	.	<table border="1" style="width: 100%; border-collapse: collapse;"> <thead> <tr> <th colspan="2" style="text-align: left;">Wired</th> <th colspan="2" style="text-align: left;">Wireless</th> </tr> </thead> <tbody> <tr> <td style="width: 5%;">A</td> <td style="width: 40%;">RS-232C</td> <td style="width: 5%;">1</td> <td style="width: 50%;">Bluetooth</td> </tr> <tr> <td>B</td> <td>TTL</td> <td>2</td> <td>IrDA</td> </tr> <tr> <td>C</td> <td>USB</td> <td>0</td> <td>None</td> </tr> <tr> <td>D</td> <td>RS-485</td> <td></td> <td></td> </tr> <tr> <td>E</td> <td>Parallel</td> <td></td> <td></td> </tr> <tr> <td>Z</td> <td>None</td> <td></td> <td></td> </tr> </tbody> </table>	Wired		Wireless		A	RS-232C	1	Bluetooth	B	TTL	2	IrDA	C	USB	0	None	D	RS-485			E	Parallel			Z	None		
S40																																			
SC30																																			
W25																																			
.																																			
.																																			
.																																			
Wired		Wireless																																	
A	RS-232C	1	Bluetooth																																
B	TTL	2	IrDA																																
C	USB	0	None																																
D	RS-485																																		
E	Parallel																																		
Z	None																																		

Example) 1. Porti-S40 UART/Bluetooth Part No. ⇒ S40/A1
 2. Porti-SC30 Bluetooth Only Part No. ⇒ SC30/Z1

Note) The above table is the interface format which is supported.
 But some of the interfaces are not supported according to the product
 and please contact us, if you have any questions regarding the interface.

1.4. Specifications.

Item	Specification	
Printing method	Direct thermal line printing	
Character size	- Font Size A: 12X24 / Font Size B : 9X24 / Font Size C : 8X16 - KOR : 24X24(16X24) / CHN, JPN : 24X24	
Characters per line	- Font A : 69cpl / Font B : 92cpl / Font C : 104cpl - KOR, CHN, JPN : 34cpl	
Optional Characters	Alphanumeric:95, Extended Graphics:128X50 pages, International:10, Simplified/Traditional Chinese, Japanese, Korean	
Resolution	203dpi, 8dots/mm	
Print width	4-inch (104mm, 832dots)	
Printing speed	50mm / sec (MAX)	
Dimensions	138.4 x 88.5 x 45.2 mm	
Weight (w/o paper)	281g	
Interface	UART(RS-232C or TTL) , Bluetooth Ver3.0 interface USB[option]	
Paper supplied	Thermal roll paper (113mm wide, 38ø)	
Barcode supplied	1-dimension : Code128, Code39, I2/5, Code93 UPC, EAN, KAN,JAN, CODABAR 2-dimension : PDF417, QR Code, DATA Matrix	
Driver	Microsoft Windows, Linux	
H/W spec.	MCU : 32bits RISC, FLASH : 4Mbytes, RAM : 8Mbytes	
Receive buffer size	1M bytes	
Sensor	Support Paper, Label	
Battery	Rechargeable 7.4V DC, 1300mAh/1880mAh (Li-ion)	
Battery duration	1 hour continuous printing	
Battery Charger	Input (100~240V AC 50~60Hz) Output(8.4VDC/0.8A), 4hours full charge time	
Environment Conditions	Temperature	-10°C ~ 50°C (operating) -10°C ~ 70°C (storage)
	Humidity	30% - 80% (operating) 10% - 90% (storage)
MCBF (Mean Cycle Between failure)	Mechanical	37,000,000 lines
	Head	Approximately 50Km

< Table 1 >

2. Setting up the printer

2.1. Printer & Accessories

Your printer box should include these items. If any items are damaged or missing, please contact your dealer for assistance.

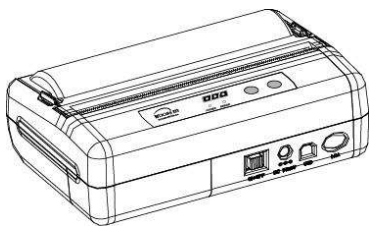

PORTI-W40

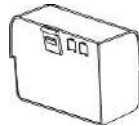

Battery Pack



Communication cable

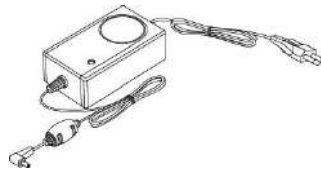

Battery charger adaptor

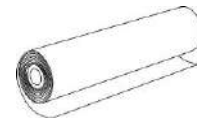

Thermal roll paper

▼ OPTIONAL

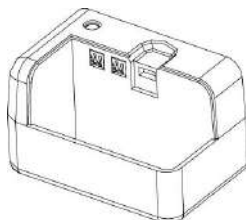

External Battery Cradle

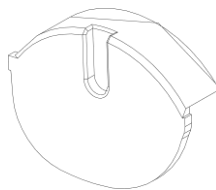

3inch Guide

2.2. Printer Features

2.2.1. Part name

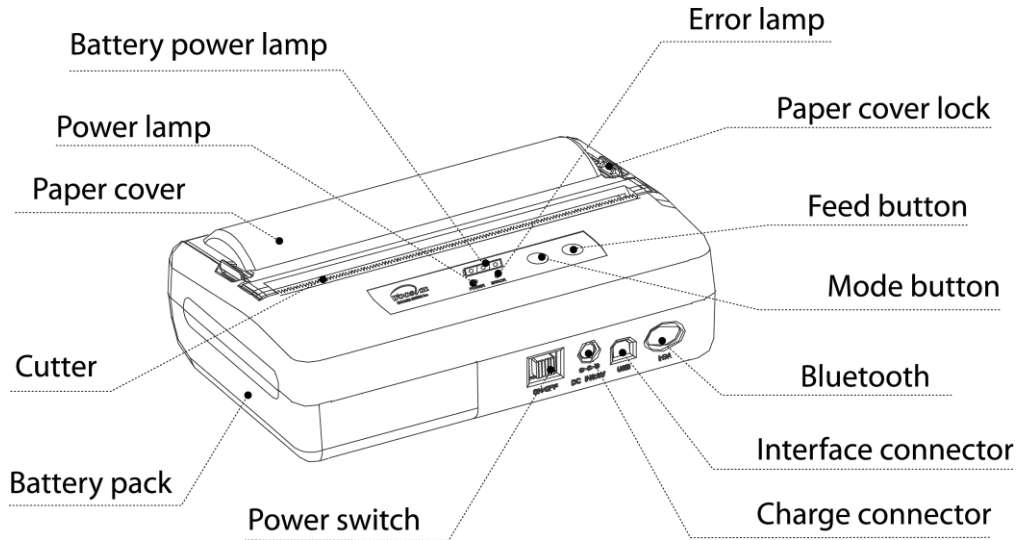

2.2.2. Dimensions

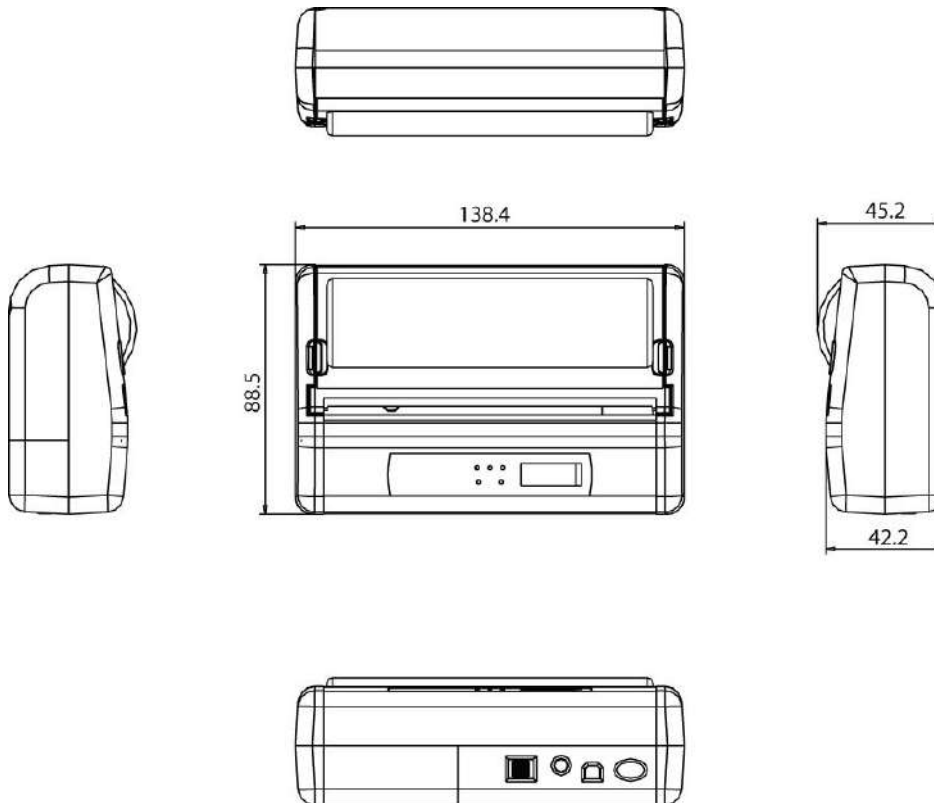

2.4. Replacing the paper roll

Note : Be sure to use paper rolls that meet the specifications.
 Do not use paper rolls that have the paper glued to the core because the printer can not detect the paper end correctly.

1. Make sure that the printer is not receiving data; otherwise, data may be lost.
2. Open the paper cover using finger on both side of printer, and remove the remaining paper.

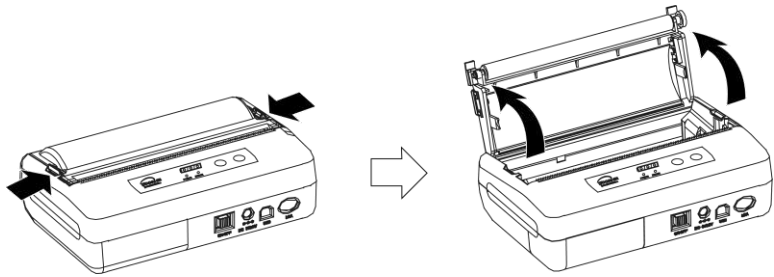

3. Insert the paper roll as shown.

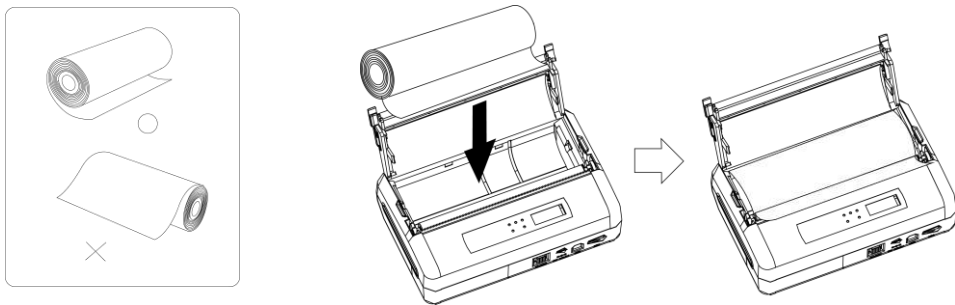

4. We could be use 3inch roll paper with the 3inch guide, as shown.

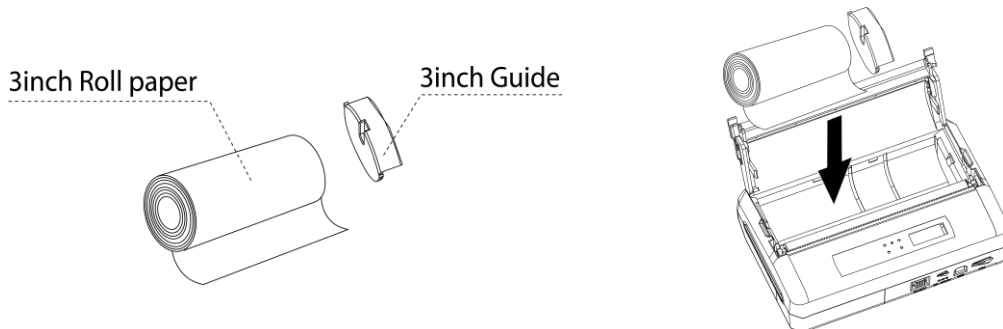

5. Tear the excess paper off using the edge of paper door as a tear bar.

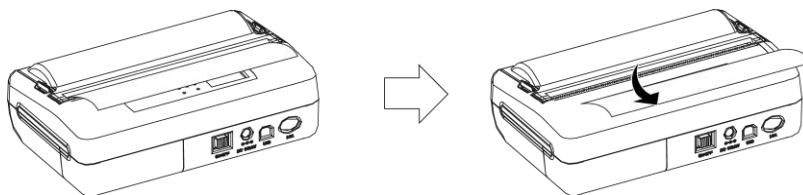

2.5. Power supply

2.5.1. Internal power supply

The following specification is requested for Power supply.

Battery Charger : DC 8.4V/0.8A

Avoid using power supply which its power capacity of power current is extremely high.

2.5.2. Installing the Battery

Warning :

- Before installing or removing the battery pack, ensure the printer is OFF.
- If the printer is not used for long period of time, remove the battery pack from the printer.
- Risk of explosion if battery is replaced by an incorrect type.
Dispose of used batteries according to the instructions.
- Batteries are provided not being charged. Please charge the battery before use.

① To install battery pack, proceed as follows:

-Insert the Battery Connector in the direction of the arrow.

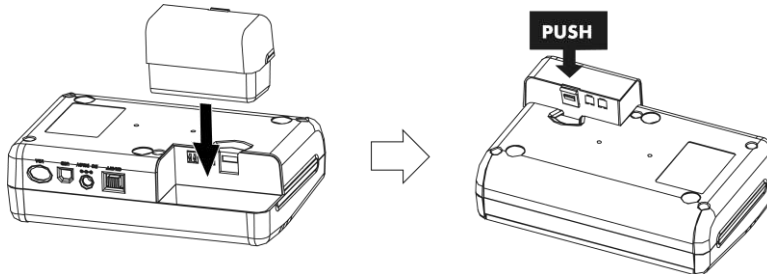

② Removing the battery pack

- Turn the printer power off and push the battery pack lock and to lift up the direction of the arrow.

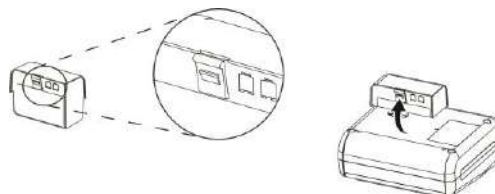

③ The battery pack install into External Battery Cradle.

- Insert the battery pack in the direction of the arrow.

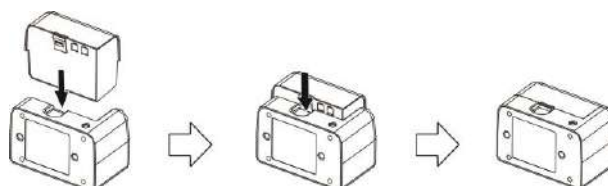

2.5.3. Recharging the battery

For recharging the battery pack, install the battery pack in the printer or the battery holder. Insert the battery charge adaptor to the charge connector of the printer or the External Battery Cradle.

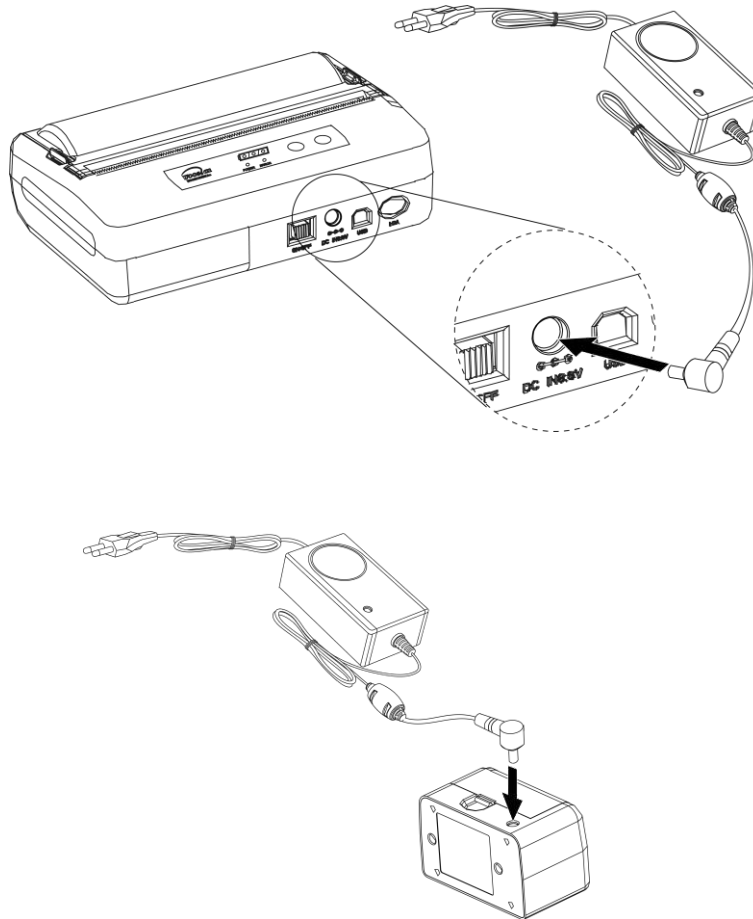

- NOTE :**
- While charging the printer, turn off the printer power.
 - Do not remove the battery during charging.
 - The battery is consumable parts and when purchasing, compared to the use hour is gradually decreases. (Warranty 6 month)
 - If the printer is not used for a long time, unplug the power cord from the printer and outlet.
 - The recharging time depends on the voltage level and ambient temperature of the battery. Normally, it takes about 4 hours to recharge a battery pack.
 - You must use only the supplied adapter.
 - Red Lamp : charging the battery.
 - Green Lamp : charging is finished.

2.6. Set operation mode

In keeping on pressing the Feed and Power button simultaneously until after the **ERROR lamp** blinks 5 times, the printer comes out at the circumstance to change the printer mode.

(refer to Table 2)

- **POWER button** : use for changing OPTION status. (**Error Lamp**)
- **FEED button** : use for changing MODE status. (**Power Lamp**)

[Example] The defaults of the printer are :

RS-232C / 9600 bps / 8 data bit / No parity / 1 stop bit / Density low
/ Mark use / Sensor low / Power down 5 minute

If a user wants to modify the defaults with

Bluetooth / 57600 bps / 7 data bit / Odd parity / 2 stop bit / Density high
/ Mark no use / Sensor medium1 / Power down no use

- ▶ Press **MODE Button** during the **Error Lamp** flicking 5 times.
 - You will see the **Power Lamp** and the **Error Lamp** flickers once.
 - Press the **MODE Button** twice and the **Error Lamp** flickers 3 times.
 - And then, interface mode has set to **Bluetooth** mode.
 - ▶ When you press **FEED button** once again, **Power Lamp** flickers twice and the **Error Lamp** flickers once.
 - Press **MODE Button** 3 times, **Error Lamp** flickers 4 times.
 - And then, baudrate has set to **57,600 bps**.
 - ▶ When you press **FEED Button** once again, **Power Lamp** flickers 3 times and the **Error Lamp** flickers twice.
 - Press **MODE Button** once, **Error Lamp** flickers once.
 - And then Data Bit has set to **7 data bit**.
 - ▶ When you press **FEED Button** once again, **Power Lamp** flickers 4 times and the **Error Lamp** flickers once.
 - Press **MODE Button** once, **Error Lamp** flickers twice.
 - And then the Parity bit has set to **Odd parity bit**.
 - ▶ When you press **FEED Button** once again, **Power Lamp** flickers 5 times and **Error Lamp** flickers once.
 - Press **MODE Button** once, **Error Lamp** flickers twice.
 - And then the density has set to **2 stop bit**.

- ▶ When you press **FEED Button** once again, **Power Lamp** flickers 6 times and **Error Lamp** flickers once.
 - Press **MODE Button** twice, **Error Lamp** flickers 3 times.
 - And then the density has set to **Density high**.
- ▶ When you press **FEED Button** once again, **Power Lamp** flickers 7 times and **Error Lamp** flickers twice.
 - Press **MODE Button** once, **Error Lamp** flickers once
 - And then the mark has set to **Mark no use**.
- ▶ When you press **FEED Button** once again, **Power Lamp** flickers 8 times and **Error Lamp** flickers once.
 - Press **MODE Button** once, **Error Lamp** flickers twice
 - And then the sensor has set to **Sensor medium1**.
- ▶ When you press **FEED Button** once again, **Power Lamp** flickers 9 times and **Error Lamp** flickers five times.
 - Press **MODE Button** once, **Error Lamp** flickers once
 - And then the power down has set to **Power down no use**.

If all the mode have set, press the **MODE Button** and the **FEED Button** at the same time after then release the buttons at the same time.

The printer will print out the mode status which has modified.

(Bluetooth / 57600 bps / 7 data bit / Odd parity / 2 stop bit / Density high / Mark no use / Sensor medium1 / Power down no use)

If the status is not correct, please try it again according to the procedure.

MODE	POWER Lamp (Green)	ERROR Lamp (Red)	Option	
Communication Port	1	1	UART(RS-232C)	USB
		2	Protocol UART(RS-232C)	USB(Pro)
		3	Bluetooth	
		4	Protocol Bluetooth	
Baud Rate	2	1	9600 bps	
		2	19200 bps	
		3	38400 bps	
		4	57600 bps	
		5	115200 bps	
Data Bit	3	1	7 Data bit	
		2	8 Data bit	
Parity	4	1	No Parity	
		2	Odd Parity	
		3	Even Parity	
Stop bit	5	1	1 stop bit	
		2	2 stop bit	
Density	6	1	Density Low	
		2	Density Medium	
		3	Density High	
Mark	7	1	No use	
		2	Use	
Sensor	8	1	Low	
		2	Medium1	
		3	Medium2	
		4	High	
Power Down	9	1	No use	
		2	1 minute	
		3	2 minute	
		4	3 minute	
		5	4 minute	
		6	5 minute	

< Table 2 >

3. Interface

3.1. UART(RS-232C or TTL) or USB

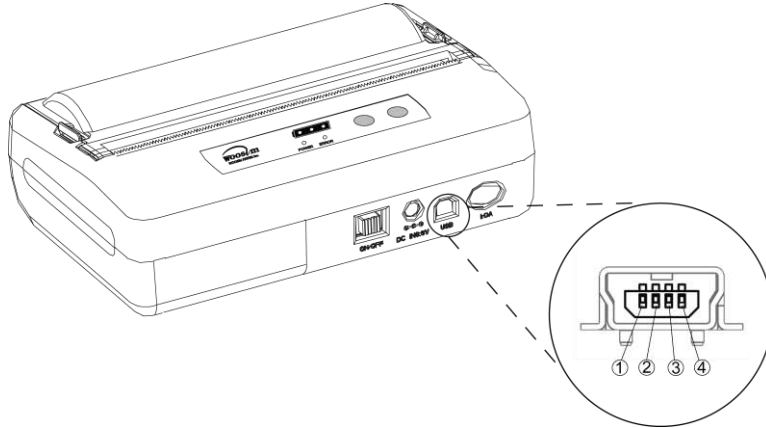

(Fig.3.1)

The Porti-W40 printer has a UART(RS-232C or TTL) or USB interface and is connected by means of a 5 pin mini USB socket.

In the following table, the signals present on the Mini- USB socket are listed:

① **UART**

Pin No.	Name	Direction	Function
1	TxD	Output	Transmit Data
2	RxD	Input	Receive Data
3	GND	-	Ground
4	NC.	-	-
5	GND	-	Ground

② **USB**

Pin No.	Name	Function
1	VCC	+5V
2	DM	DATA "-"
3	DP	DATA "+"
4	NC.	-
5	GND	Ground

NOTE :

- If you connect the printer interface cable is converted to UART or USB mode.
- When data receiving, when it removes the communication cable, it loses a data.

3.2. Bluetooth

Category	Specification
Bluetooth Spec.	Bluetooth Ver3.0 / Class2 (10m)
Frequency band	2402~2480 MHz
Protocol	L2CAP, RFCOMM, SDP
Profile	GAP, SDAP, SPP

4. Using the printer

4.1. Control panel

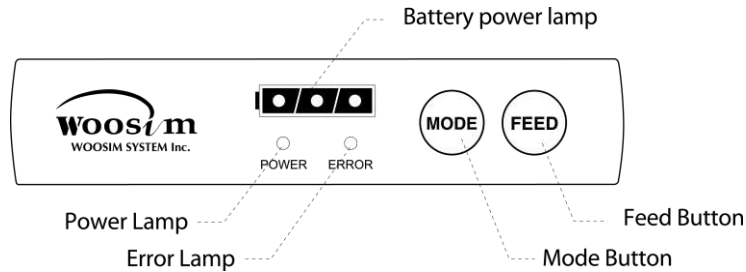

(Fig.4.1)

► Button

- **FEED Button** : Use feed button to feed the paper continuously.
- **MODE Button** : MODE Button is for use to change communication mode.
Do not operate the mode button without instructions.

► LAMP

- **Power** : Printer is ON and ready to receive data.
(GREEN)
- **Error** : Indicates a fault condition or a printer error.
(RED) (details: no paper, paper cover opened. etc.)
- **Battery Power** : These lamps(Green) indicated the battery power remaining.
(GREEN) The battery gain in quantity and these lamps are on the decrease.
If so, you must recharge the battery by using the battery charger.

4.2. The self test

Self-Test prints out the current setting value of printer. The way of self-test is as follows.

1. Insert proper paper into the printer.
2. Power on while pressing feed button to start self-test.
3. Printer will print out the current status. (F/W version and set contents)
4. And then pattern of characters will be printed out.
5. Self-test will be finished automatically and turned to the standby status.

※ In case printer does not work properly, please contact Woosim customer service center.

5. Consumable Parts

5.1. Recommended paper

Type	: Thermal Paper
Paper width	: 113mm
Paper thickness	: $60 \pm 5 \mu\text{m}$
Outer diameter	: $\text{Ø}38\text{mm}$ or less
Recording side	: Outside of roll



Cautions

1. Do not paste the paper to the core. And the roll paper which has Near end mark printing on its near end is recommended.
2. Chemicals or oil may change the color of paper, or printed Characters may fade.
3. Change of paper color starts from approx 70 °C.
Pay attention to heat, humidity and sun light.
4. Color of paper may be changed by being scratched by nail or hard metal, etc

5.2. Printing position

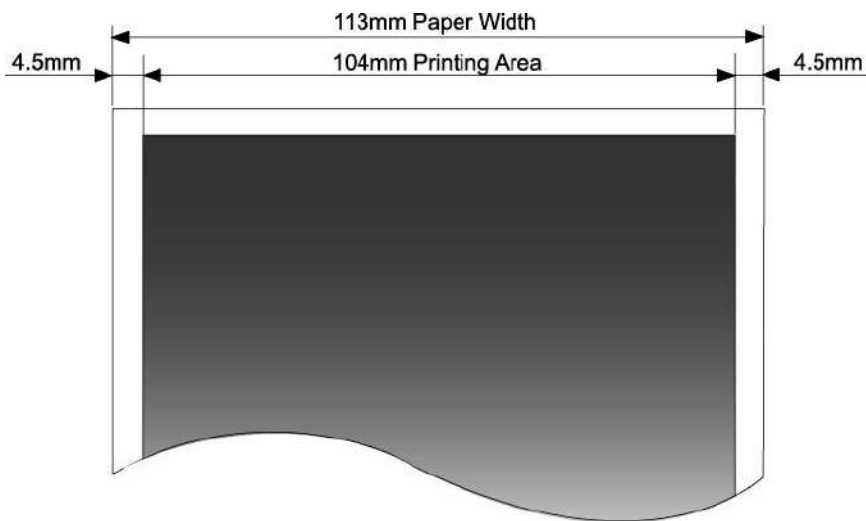

6. Revision History

Date	Version	Comments
Jan. 18. 2018	3.1	Renewal

The logo for UTING, featuring the word "UTING" in a bold, blue, sans-serif font with a white outline and a slight shadow effect.

PORTI-W40

Türkiye Genel Dağıtım:
Uting Elektronik ve Endüstriyel Ürünler, Mümessillik,
Dış Ticaret ve San. Ltd.Şti.
Adres: Çobançeşme, Gençosman Sokak no:10
34196 Yenibosna - İSTANBUL
www.utingelektronik.com
Tel: 0212- 639 20 95 Fax: 02120 639 32 19

Üretici Firma:

WOOSIM SYSTEMS INC.
#60, Sandan-ro 388 beon-gil, Galsan Myeon,
Hongseong-gun, Chungcheongnam-do
32200 S.Korea
Tel: +82 41 339 3700
Fax: +82 41 339 3701