

MODEL WSP-i450

(4inch Rugged Mobile Printer)

Rev. 6.5

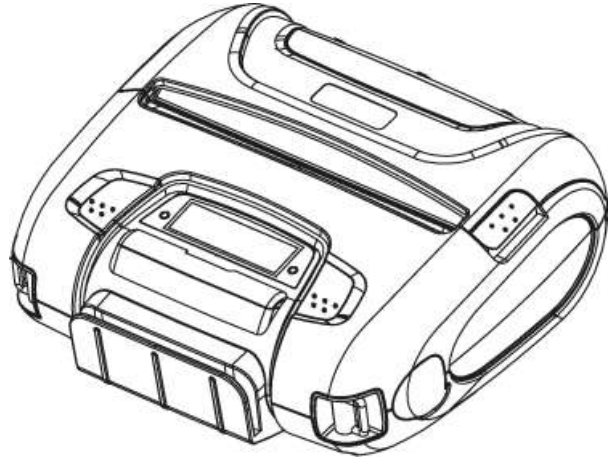

UTING®
ELEKTRONIK

Türkiye Genel Dağıtım:
Uting Elektronik ve Endüstriyel Ürünler, Mümessillik,
Dış Ticaret ve San. Ltd.Şti.

www.utingelektronik.com

Tel: 0212- 639 20 95,-96,-97 Fax: 0212- 639 32 19

All specifications are subjected to change without notice

■ Copyright

WSP-i450 4inch Rugged mobile printer operator's manual.

Copyright ©2020 by Woosim Systems Inc.

All rights reserved.

The information contained in this manual is the property of Woosim Systems Inc.

And may not be reproduced in whole or in part without the prior written permission of Woosim Systems Inc.

■ Trademark



a registered trademark of Woosim Systems Inc.

All other trademark are the properties of their respective companies.

■ Caution

Some semiconductor devices are easily damaged by static electricity. You should turn the printer "OFF", before you connect or removed the cable on the rear side, in order to guard the printer against the static electricity.

If the printer is damaged by the static electricity, you should turn the printer "OFF"

■ Notice

The contents of this manual are subject to change without notice.

■ Introduction

The **WSP-i450** is the ideal solution for Mobile banking system , Retail, point of sales, Credit card Transaction, other traveling and mobile computing etc.

The general features of **WSP-i450** printer are as follows:

- ▶ Compact size (150.9×136.4×63.3mm)
- ▶ Light weight(596g) for true mobility
- ▶ Very silent printing thru direct thermal printing method
- ▶ High speed (110mm/sec, MAX)
- ▶ High resolution(203dpi : 8dots/mm).
- ▶ UART(RS-232C or TTL), Bluetooth Ver3.0,
USB[option], Wireless LAN(IEEE802.11b/g/n) [option] interface
- ▶ Support Graphic LCD(128×32dots) with Blue LED Backlight
- ▶ Support Magnetic Stripe Reader [option]
- ▶ Support Smart Card Module [option]
- ▶ Support text and graphic printing
- ▶ Intuitive LED's indicate Power(on/off), Error
- ▶ Easier paper roll loading by CLAMSHELL design
- ▶ One touch paper cover
- ▶ Printer door open & Paper-out sensor
- ▶ Easier maintenance with self-diagnostic.
- ▶ In field programming – Update Firmware, Download Fonts and Logos
- ▶ Water-resistant construction.(IP54 – Certified)
- ▶ Microsoft Windows/Windows CE, Linux, Android, iOS compatible
- ▶ Flow control : Software (XON/XOFF)
 - ※ Hardware flow control not supported in printer.
- ▶ Free fall: 1.8 meter
- ▶ Agency Approval



■ Operating Precautions

Please follow the precautions below to enjoy and maintain the full performance of the printer.

▶ Using the Printer

- Be careful not to drop or bump the printer on a hard surface.
- Do not install the printer in direct sunlight or such areas.
Suitable environment for the use of the printer is as follows:
 - ◆ Operating temperature : -20°C to 50°C
 - ◆ Relative humidity : 30% to 80%
- Do not install the printer near devices that generate strong electromagnetic fields such as a copy machine.
- Do not open the platen cover during printing .
- Do not remove or reinstall the communication cable during printing or transmission.
- Do not touch the connectors of the communication during printing.
- Switch the POWER OFF when not in use.
- Do not use other solvent.
- The AC adapter, the battery charger and the battery pack may become warm when in use. This is normal and is not a malfunction.
- When the battery pack is used at low temperature, the length of time the printer can be used may be shortened.

▶ Thermal Paper Handling

- Store the thermal paper in a cool, dry and dark place.
- Do not rub the paper with hard object.
- Do not leave the paper with hard object.
- Do not allow plastic film, erasers, or adhesive tape to touch the paper for long periods.
- Do not stack the thermal paper with diazo copies immediately after copying or wet-type copies.
- Do not use chemical glue.
- Always use the clean thermal paper.

**Federal Communications Commission
Radio Frequency Interference Statement**

FCC ID : QDDWSP-I450X

This device complies with Part 15 of the FCC Rules. Operation is subject to the following two conditions:

(1) This device may not cause harmful interference, and (2) this device must accept any interference received, including interference that may cause undesired operation.

CAUTION: Changes or modifications not expressly approved by the party responsible for compliance could void the user's authority to operate the equipment.

Note: This equipment has been tested and found to comply with the limits for a Class B digital device, pursuant to part 15 of the FCC Rules. These limits are designed to provide reasonable protection against harmful interference in a residential installation. This equipment generates, uses and can radiate radio frequency energy and, if not installed and used in accordance with the instructions, may cause harmful interference to radio communications. However, there is no guarantee that interference will not occur in a particular installation. If this equipment does cause harmful interference to radio or television reception, which can be determined by turning the equipment off and on, the user is encouraged to try to correct the interference by one or more of the following measures:

- Reorient or relocate the receiving antenna.
- Increase the separation between the equipment and receiver.
- Connect the equipment into an outlet on a circuit different from that to which the receiver is connected.
- Consult the dealer or an experienced radio/TV technician for help.

Modifications not expressly approved by the manufacturer could void the user's authority to operated the equipment under FCC rules.

This Device has been evaluated to comply with RF exposure requirement for general use limit in portable condition. It is safe to be used in sold condition.

CE WARNING

- Changes and modifications not expressly approved by the party responsible for compliance could void the user's authority to operate the equipment.
- It is desirable that it be installed and operated with at least 20cm or more between the radiator and person's body(excluding extremities hand, wrists, feet, and ankles)

CONTENTS

1. Outline	8
1.1. Model classifications	8
1.2. Symbol	8
1.3. Product Part Number System	9
1.4. Specifications	10
2. Setting up the printer.....	12
2.1. Printer & Accessories	12
2.2. Printer Features	13
2.3. Dimensions	14
2.4. Replacing paper roll.....	16
2.5. Power supply.....	17
2.5.1. Specified power supply.....	17
2.5.2. Installing the battery	17
2.5.3. Recharging the battery pack.....	18
2.6. Set operation mode	19
2.6.1. GAP/HOLE SENSOR SETTING	21
2.7. Confirmation of the Wireless-LAN information	23
2.7.1. MAC Address printing.....	23
2.7.2. Confirmation of the Wireless-LAN setting information.....	23
3. Interface.....	24
3.1. UART or USB	24
3.2. Bluetooth	25
3.3. Wireless LAN	25
3.4. Magnetic stripe card reading & IC Card insert (option)	25
4. Smart Card Module	26
4.1. General Spec	26
4.2. Inserting the SAM card.....	26
4.3. Communication Protocol Sequence	27
4.3.1. Regular Operation.....	27
4.3.2. Irregular Operation (Communication Error).....	27
5. Using the printer.....	28
5.1. Control panel	28
5.2. The self test.....	29
5.3. Using the Accessory.....	29
5.3.1. Using the Shoulder strap.....	29
5.3.2. Using the Belt clip	30



6. Consumable Parts 31
 6.1. Recommended paper. 31
 6.2. Printing position. 31
7. Revision History 32

1. Outline.

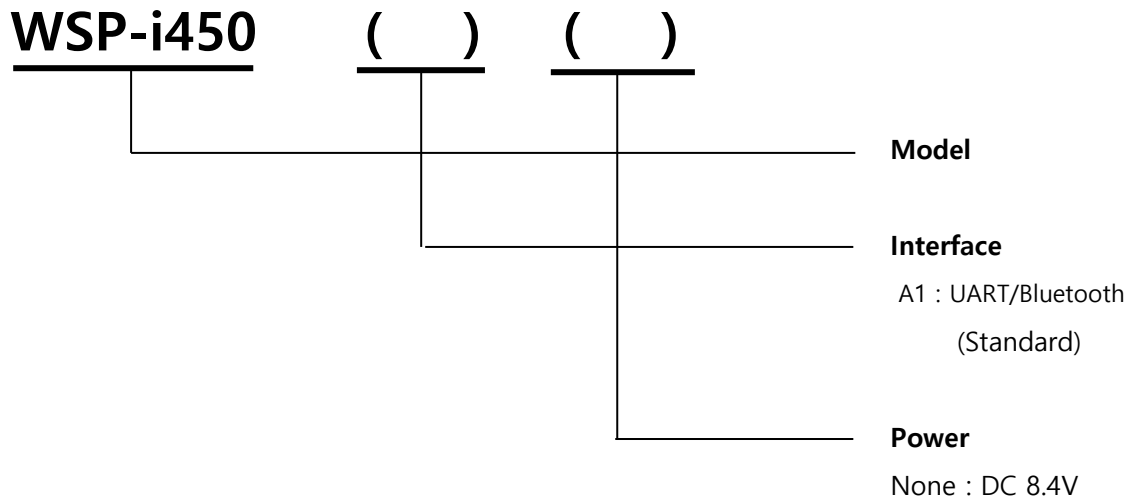
1.1. Model classifications.



1.2. Symbol

	<p>Standby symbol IEC 5009, the standby symbol(line partially within a broken circle), Indicates a sleep mode or low power state.</p>
	<p>Direct current symbol This symbol is found on many electronic devices that either require or produce direct current.</p>

1.3. Product Part Number System

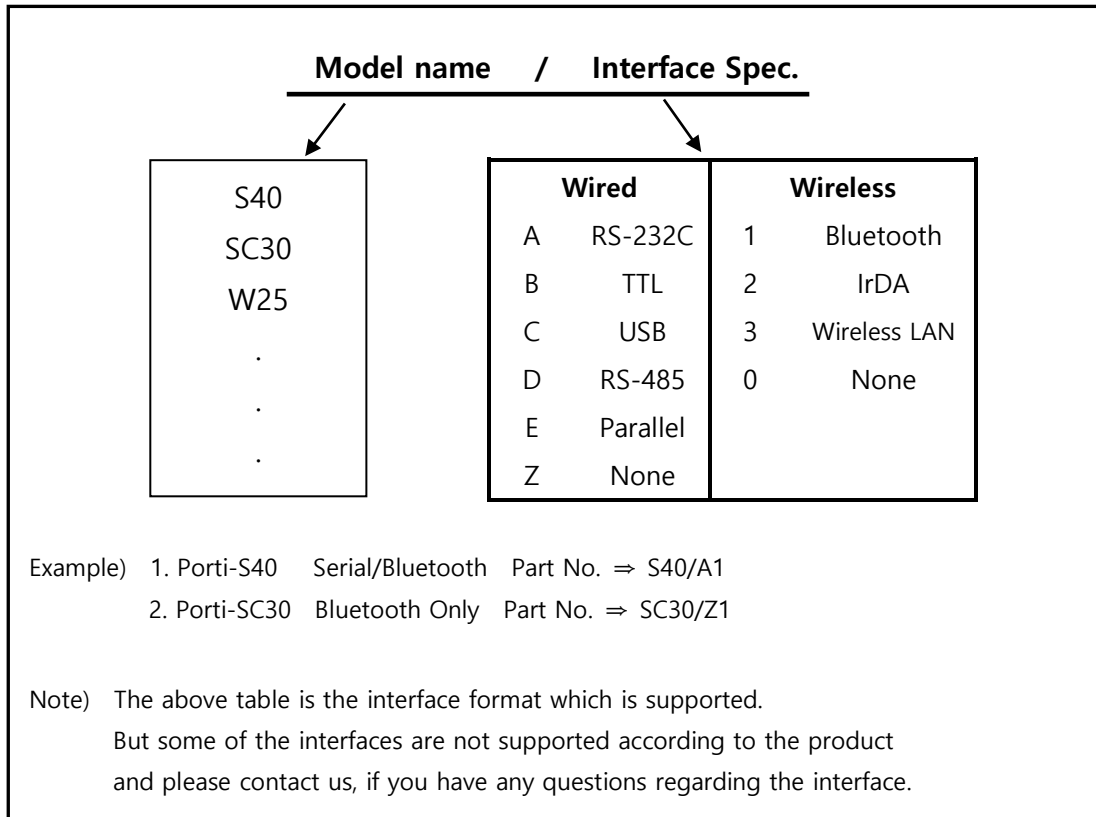

1.4. Specifications.

Item	Specifications
Print method	Direct thermal line printing
Character size	- Font Size A: 12X24 / Font Size B : 9X24 / Font Size C : 8X16 - KOR : 24X24(16X24) / CHN, JPN : 24X24
Characters per line	- Font A : 69cpl / Font B : 92cpl / Font C : 104cpl - KOR, CHN, JPN : 34cpl
Optional Characters	Alphanumeric:95, Extended Graphics:128X50 pages, International:10, Simplified/Traditional Chinese, Japanese, Korean(optional)
Resolution	203dpi, 8dots/mm
Print width	4-inch (104mm, 832dots)
Print speed	110mm / sec (MAX)
Dimension	150.9×136.4×63.3mm 150.9×143.2×63.3mm [MSR Model]
Weight (w/o paper)	596g / 609g [MSR Model]
Interface	UART(RS-232C or TTL), Bluetooth Ver3.0, USB[option], Wireless LAN(IEEE802.11b/g/n) [option]
Paper roll	Thermal roll paper (113mm wide, 50ø)
Barcodes	1-dimension : UPC-A, UPC-E, EAN-8, EAN-13, CODE-39, CODE-93, CODE-128, ITF, CODABAR 2-dimension : PDF417, Micro PDF417, Truncated PDF417, QR-CODE, DATA Matrix, Maxicode Etc :GS1 databar
Driver	Microsoft Windows, Linux
H/W Spec	MCU : RX-32bit, RAM : 128M bit, FLASH : 64M bit
Receive buffer size	1M bytes
Sensor	Support Cover open, Paper, Label
MSR [option]	Triple tracks (1&2&3 Tracks Reading) *Supports 3DES & AES encryption
Smart Card Module [option]	ISO 7816 Compliant [EMV Level 1/2 Certified] / T=0, T=1 support 1 SAM [Security Application module]
LCD	128×32 Dots FSTN (Blue LED Backlight)

(Continue...)

Item	Specifications	
Smart Card Module [option]	ISO 7816 Compliant [EMV Level 1/2 Certified] / T=0, T=1 support 1 SAM [Security Application module]	
LCD	128×32 Dots FSTN (Blue LED Backlight)	
Battery	Rechargeable 7.26V DC, 2550mAh (Li-ion)	
Battery duration	1 hour continuous printing	
Battery charger	Input (100~240V AC, 50~60Hz) Output(8.4VDC/0.8A), 4hours full charge time	
Environment conditions	Temperature	-20°C ~ 50°C (operating) -20°C ~ 70°C (storage)
	Humidity	30% - 80% (operating) 10% - 90% (storage)
MCBF (Mean Cycle Between Failure)	Mechanical	37,000,000 lines
	Head	Approximately 50 Km

< Table 1 >

2. Setting up the printer.

2.1. Printer & Accessories

Your printer box should include these items. If any items are damaged or missing, please contact your dealer for assistance.



WSP-i450

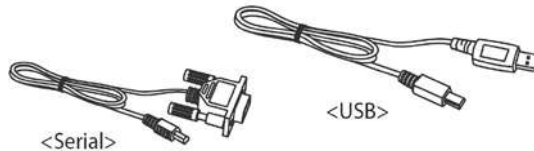

Communication cable

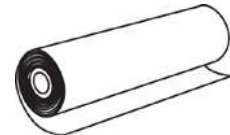

Thermal roll paper

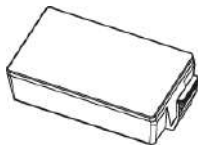

Battery Pack

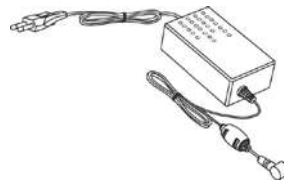

Battery charger adaptor



Belt clip

▼ OPTIONAL



External Battery
Cradle



Car charger



Shoulder strap



Smart Card Reader

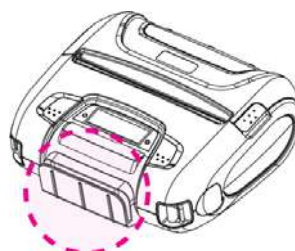

MSR

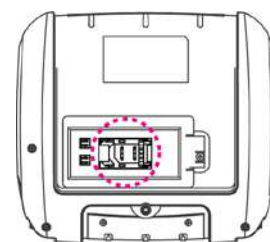

1 SAM

2.2. Printer Features

► Part Name

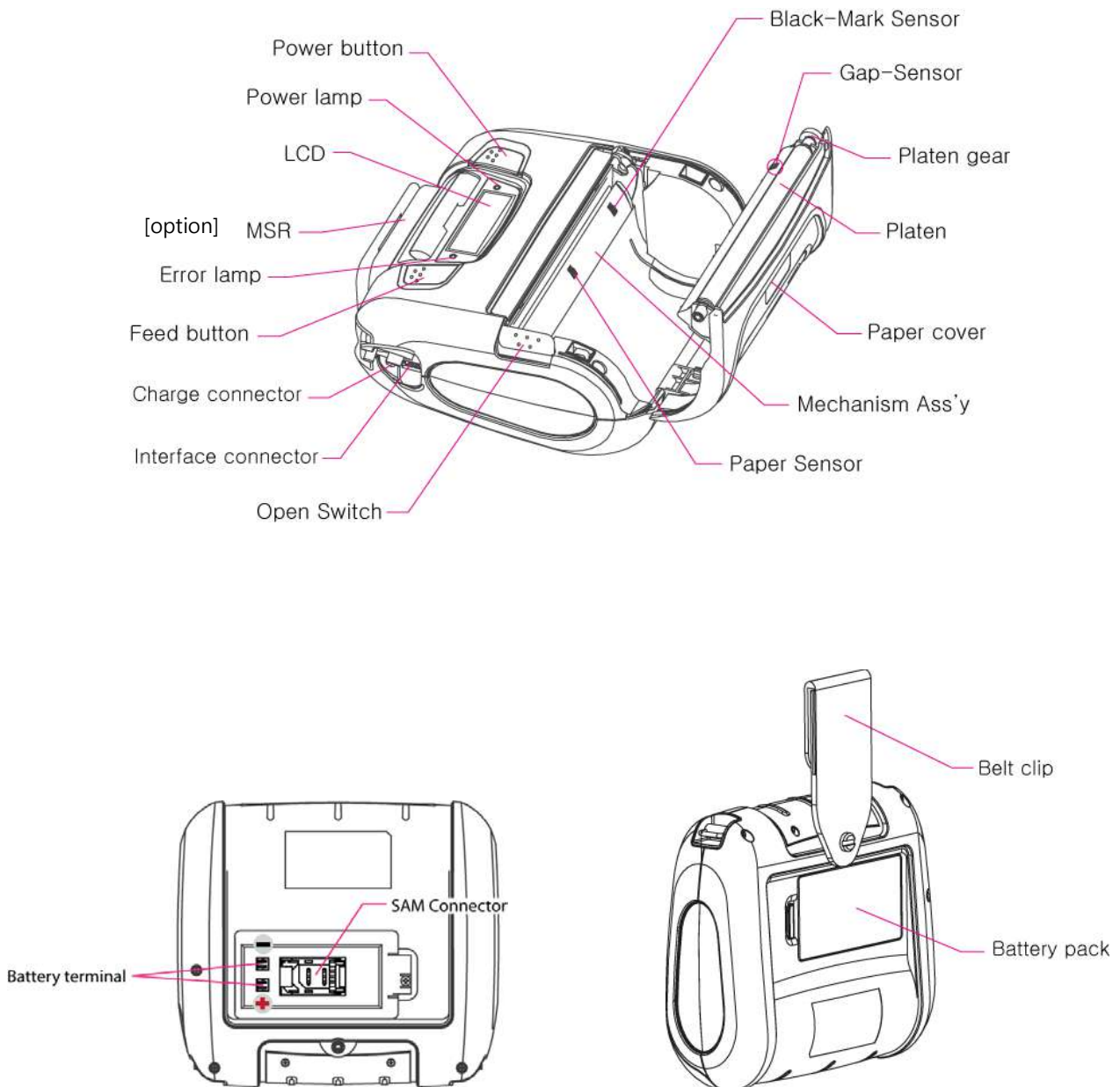

2.3. Dimensions

► Standard Model

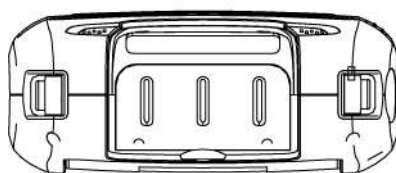
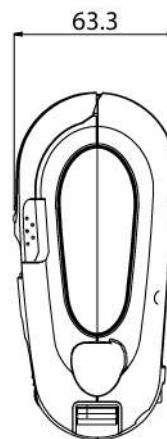
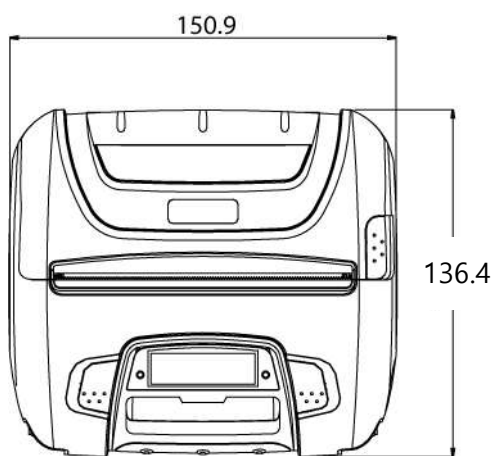
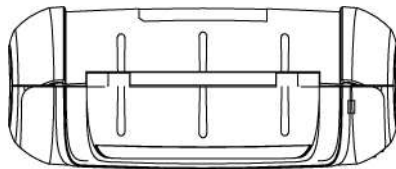

► MSR Model

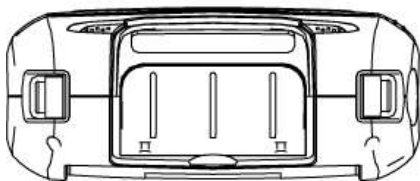
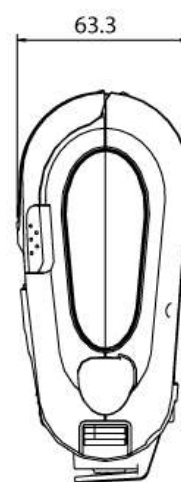
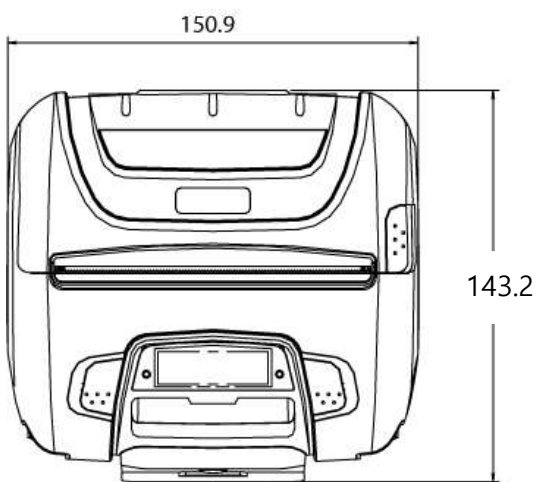
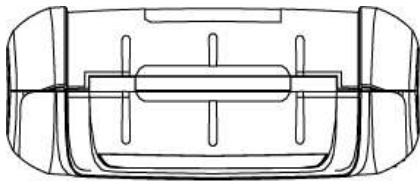

2.4. Replacing paper roll.

Note : Be sure to use paper rolls that meet the specifications.

Do not use paper rolls that have the paper glued to the core because the printer can not detect the paper end correctly.

1. Make sure that the printer is not receiving data; otherwise, data may be lost.
2. Open the paper cover as the “One-Touch” way by pressing the button in the arrow direction like the picture.

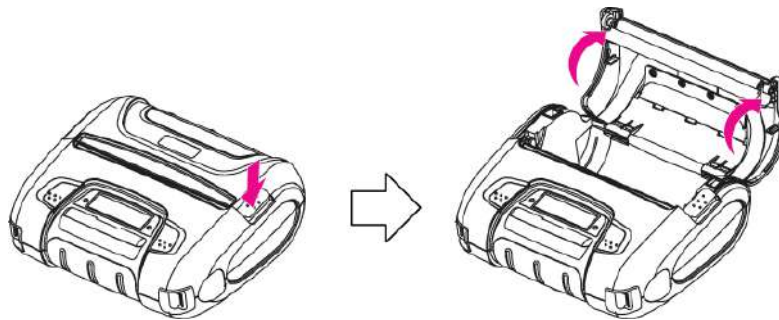

3. Insert a new paper roll as shown.

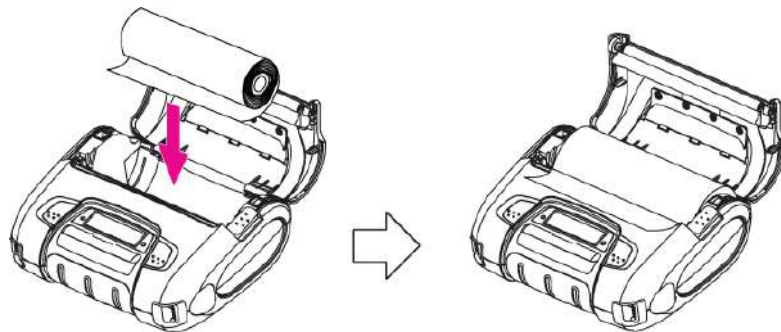
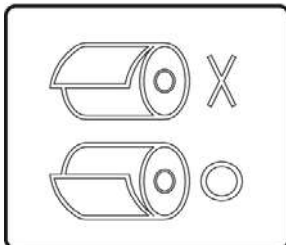

4. Tear the excess paper off using the edge of paper door as a tear bar.

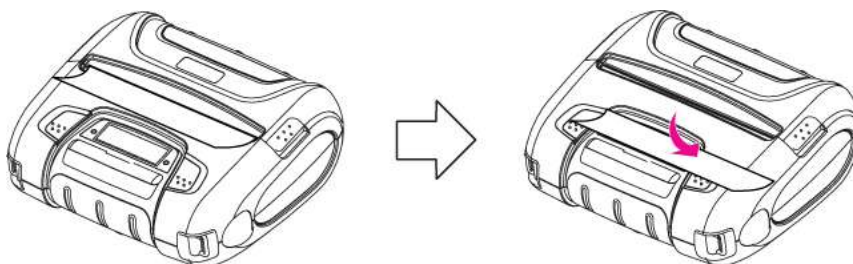

2.5. Power supply

2.5.1. Specified power supply

The following specification is requested for Power supply.

Battery Charger : DC 8.4V/0.8A

Avoid using power supply which its power capacity of power current is extremely high.

2.5.2. Installing the battery

Warning :

- Before installing or removing the battery pack, ensure the printer is OFF.
- If the printer is not used for long period of time, remove the battery pack from the printer.
- Risk of explosion if battery is replaced by an incorrect type.
Dispose of used batteries according to the instructions.
- Batteries are provided not being charged. Please charge the battery before use.

① To install Battery Pack, proceed as follows:

-Insert the Battery Pack in the direction of the arrow.

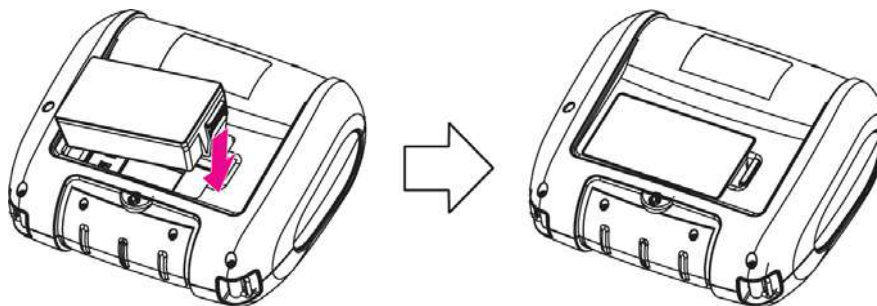

② To remove battery pack, proceed the above order reverse.

2.5.3. Recharging the battery pack

For recharging the battery pack, install the battery pack in the printer.
Insert the Battery Charger to the charge connector of the **printer**.

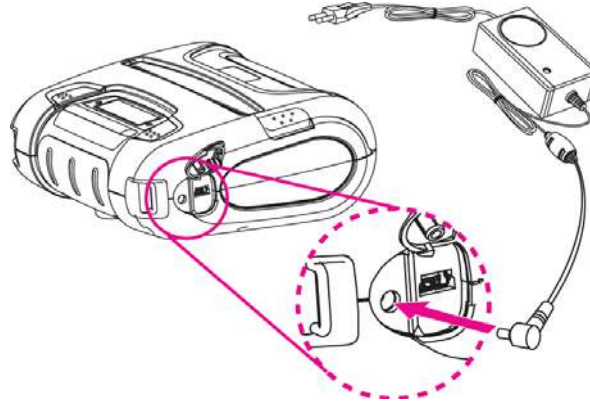

Insert the Battery charger adaptor to the charge connector of the **External Battery Cradle**.

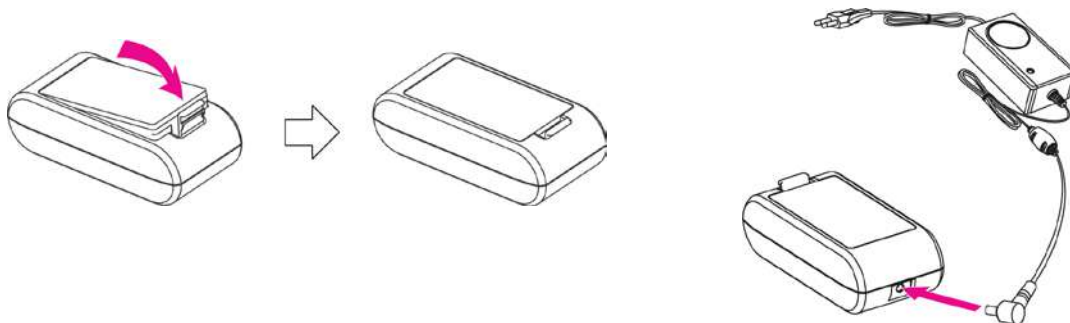

- NOTE :**
- While charging the printer, turn off the printer power.
 - Do not remove the battery during charging.
 - The battery is consumable parts and when purchasing, compared to the use hour is gradually decreases. (Warranty 6 month)
 - If the printer is not used for a long time, unplug the power cord from the printer and outlet.
 - The recharging time depends on the voltage level and ambient temperature of the battery. Normally, it takes about 4 hours to recharge a battery pack.
 - You must use only the supplied adapter.
 - Red Lamp : charging the battery.
Green Lamp : charging is finished.

2.6. Set operation mode

In keeping on pressing the Feed and Power button simultaneously until after the **ERROR lamp** blinks 5 times, the printer comes out at the circumstance to change the printer mode. (refer Table 2)

** Only the printer which support iOS Bluetooth interface comes out at the circumstance to change the printer mode. (Bluetooth Mode or Bluetooth(iAP) Mode).

** Manipulation methods :

1. Press Feed and Power buttons simultaneously until the **ERROR lamp** blinks 5 times and then keep pressing two buttons for 2 Seconds.
2. After the printer beeps twice, the Bluetooth mode is changed and it will print the result of change.
3. The changed mode can be checked in the printout.

Example) If the printer is in Bluetooth Mode → Bluetooth(iAP) Mode
If the printer is in Bluetooth(iAP) Mode → Bluetooth Mode

** If you want to change the Bluetooth Mode of printer, you need to disconnect the Bluetooth function of the current paired Smartphone.

** Methods :

1. Turn off the Bluetooth function of the current paired Smartphone.
(Bluetooth ICON in LCD is disappeared.)
2. Change the printer mode.
(Additionally, we want to recommend you to rest(OFF→ON) the printer and change mode.)

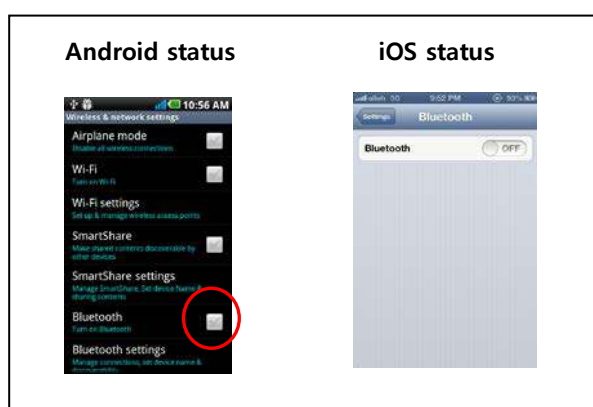
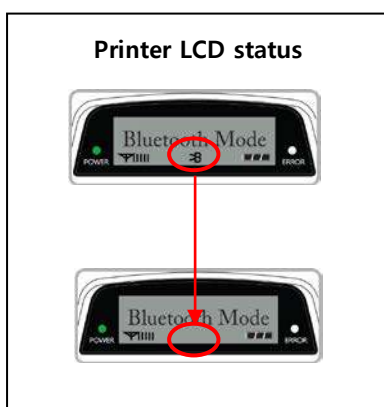

- **FEED button** : changing Printer MODE status.
- **POWER button** : changing OPTION status.

[Example] The defaults of the printer are :

**UART : 9600 bps : 8 data bit : No parity : 1 stop bit : Density low :
Quality low : Mark use : Sensor High : 5 minute**

If a user wants to modify the defaults with

**Bluetooth : 57,600 bps : 7 data bit : Odd parity : 2 stop bit : Density high :
Quality high : Gap/Hole : Sensor Low : no use**

- ▶ Press FEED & POWER Button during the **Error Lamp** flickers 5 times.
 - You will see present **COMMUNICATION** mode in the LCD. (UART)
 - Press the **POWER Button** twice. And then, interface mode has set to **Bluetooth** mode.
- ▶ When you press **FEED button** once.
 - You will see present **BAUD RATE** mode in the LCD. (9600 bps)
 - Press **POWER Button** 3 times. And then, **BAUD RATE** has set to **57,600 bps**.
- ▶ When you press **FEED button** once.
 - You will see present **DATA BIT** mode in the LCD. (8 Data bit)
 - Press **POWER Button** once. And then Data Bit has set to **7 DATA BIT**.
- ▶ When you press **FEED button** once.
 - You will see present **PARITY** mode in the LCD. (No parity)
 - Press **POWER Button** once. And then the Parity bit has set to **ODD Parity Bit.**
- ▶ When you press **FEED button** once.
 - You will see present **STOP BIT** mode in the LCD. (1 stop bit)
 - Press **POWER Button** once. And then the density has set to **2 Stop bit**.
- ▶ When you press **FEED button** once.
 - You will see present **DENSITY** mode in the LCD. (Density low)
 - Press **POWER Button** twice. And then the density has set to **Density high**.
- ▶ When you press **FEED button** once.
 - You will see present **Quality** mode in the LCD. (Low)
 - Press **POWER Button** once. And then the quality has set to **Quality high**.

- ▶ When you press **FEED button** once.
 - You will see present **MARK** mode in the LCD. (Use)
 - Press **POWER Button** once. And then the mark has set to **Mark Gap/Hole**.
- ▶ When you press **FEED button** once.
 - You will see present **SENSOR** mode in the LCD. (High)
 - Press **POWER Button** once. And then the sensor has set to **Sensor Low**.
- ▶ When you press **FEED button** once.
 - You will see present **POWER DOWN** mode in the LCD. (5 minutes)
 - Press **POWER Button** once. And then the Power down has set to
Power down no use.

If all the mode have set, press the **POWER Button** and the **FEED Button** at the same time. After then release the buttons at the same time.

Bluetooth : 57600bps : 7 data bit : Odd parity : 2 stop bit : Density high : Quality High : Gap/Hole : Sensor Low : no use

2.6.1. GAP/HOLE SENSOR SETTING

1. Set Mark as GAP / HOLE on mode setting.
2. If feed button keeps being pressed during self "SENSOR SETTING" appears on LCD window and paper keeps coming out "SENSOR SETTING".
3. If feed button is not pressed after printing more than 3 pages of label
4. Setting is completed as Green and Red LED flash and "COMPLETE" appears on LCD window.

** Caution : Sensor setting stops if the feed button is not pressed during self test.

MODE	OPTION	
	Bluetooth	WLAN
Communication Port	UART(RS-232C)	UART(RS-232C)
	Protocol UART (RS-232C)	Protocol UART (RS-232C)
	Bluetooth	WLAN
	Protocol Bluetooth	Protocol WLAN
	Bluetooth(iAP)	-
Baud Rate	9600 bps	
	19200 bps	
	38400 bps	
	57600 bps	
	115200 bps	
Data Bit	7 Data bit	
	8 Data bit	
Parity Bit	No Parity	
	Odd Parity	
	Even Parity	
Stop Bit	1 Stop bit	
	2 Stop bit	
Density	Density Low	
	Density Medium	
	Density High	
	Density High+1	
	Density High+2	
Quality	Low	
	High	
Mark	NO USE	
	USE	
	Gap / Hole	
	USE(Back)	
Sensor	Low	
	Medium1	
	Medium2	
	High	

Continue...

MODE	OPTION
Power Down	NO USE
	1min Sleep
	2min Sleep
	3min Sleep
	4min Sleep
	5min Sleep
	1min Off
	2min Off
	3min Off
	4min Off
	5min Off

< Table 2 >

Notice : Bluetooth(iAP) is the mode which is used in iPod, iPhone and iPad Whole aspect.

2.7. Confirmation of the Wireless-LAN information

2.7.1. MAC Address printing

- ▶ MAC address which is set to the printer can be printed out in pressing the Power and Feed button simultaneously and taking off them shortly after the **ERROR lamp** blinks 2 times

2.7.2. Confirmation of the Wireless-LAN setting information

- ▶ Press the Power button in the printer turning on
As the LCD backlight turns on, MAC Address is indicated.
- ▶ IP Address on LCD is indicated in pressing the Power button once again
- ▶ Subnet mask on LCD is indicated in pressing the Power button once again
- ▶ Gateway IP on LCD is indicated in pressing the Power button once again
- ▶ DNS sever IP on LCD is indicated in pressing the Power button once again

※ Since the configuration of Wireless LAN can not be done with the printer in person, you are required to use the Wireless LAN-setting program which WOOSIM offers

3. Interface

3.1. UART or USB

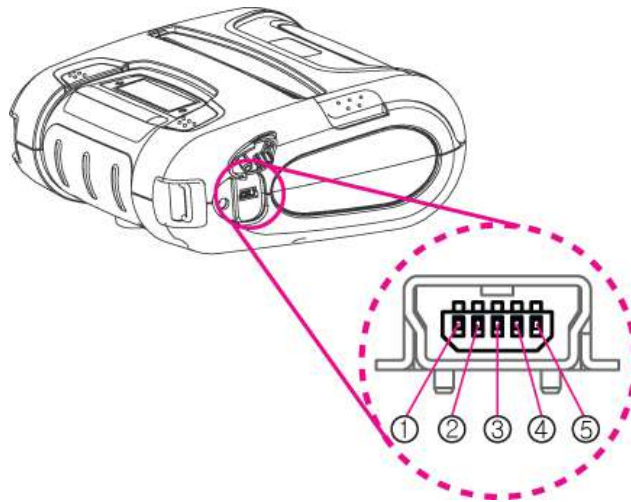

The WSP-i450 printer has a UART(RS-232C or TTL) or USB interface and is connected by means of a 5 pin mini USB socket.

In the following table, the signals present on the Mini- USB socket are listed:

① UART(RS-232C or TTL)

Pin No.	Name	Direction	Function
1	TxD	Output	Transmit Data
2	RxD	Input	Receive Data
3	GND	-	Ground
4	NC.	-	-
5	GND	-	Ground

② USB

Pin No.	Name	Function
1	VCC	+5V
2	DM	DATA "-"
3	DP	DATA "+"
4	NC.	-
5	GND	Ground

NOTE :

- If you connect the printer interface cable is converted to UART or USB mode.
- When data receiving, when it removes the communication cable, it loses a data.

3.2. Bluetooth

Category	Specification
Bluetooth Spec.	Bluetooth Ver3.0 / Class2 (10m)
Frequency band	2402~2480MHz
Protocol	L2CAP, RFCOMM, SDP
Profile	GAP, SDAP, SPP

3.3. Wireless LAN

Category	Specification
Function	Radio frequency transfer Module (IEEE802.11b/g/n standard conformity)
Frequency band	2.4GHz
Channel	1 to 13 channel
Security	WEP(64/128), WPA(TKIP), WPA2(AES)

3.4. Magnetic stripe card reading & IC Card insert (option)

Insert the Smart Card into slot with micro chip facing down.

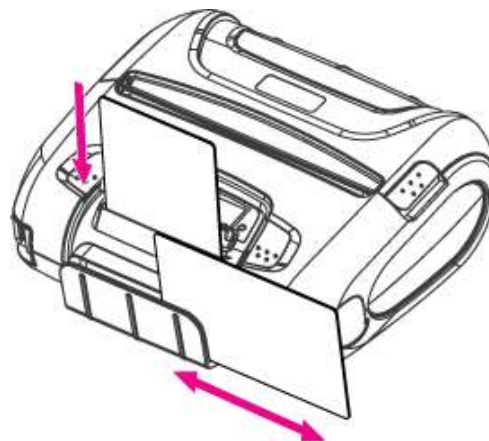

Please take notice that Magnetic Stripe Card should be swapped in direction of arrow.
Card can be read in both

4. Smart Card Module

4.1. General Spec.

- ▶ Contact Smart Card Reader Module for ISO/IEC-7816
- ▶ Support Asynchronous Protocol T=0,T=1
- ▶ Smart Card Connection
 - Short Circuit Current Limitation
 - 6KV ESD Protection on whole Smart Card Interface
 - Connector : Friction Type with Smart Card presence detection
- ▶ 1 SAM (Security Application Module)
- ▶ EMV Level 1/2 Certified

4.2. Inserting the SAM card

To install SAM card, proceed as follows:

- Insert the SAM card in the direction of the arrow.

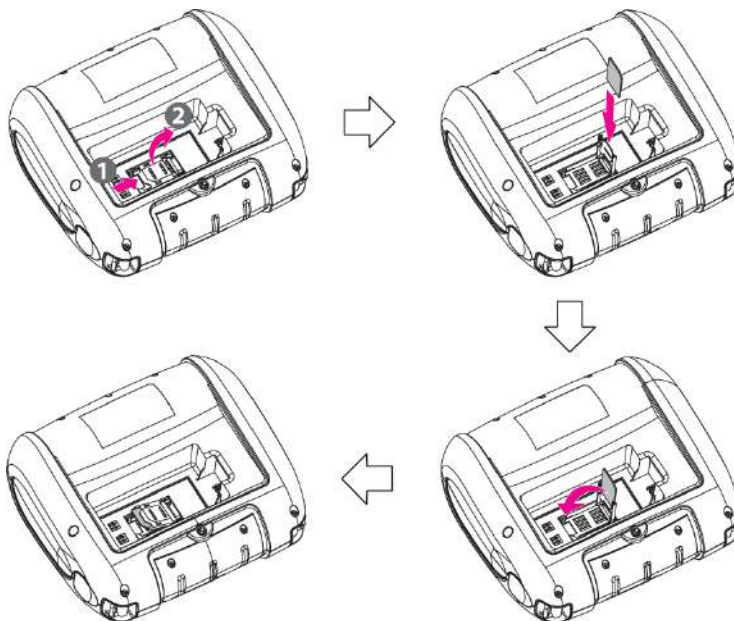

4.3. Communication Protocol Sequence

4.3.1. Regular Operation

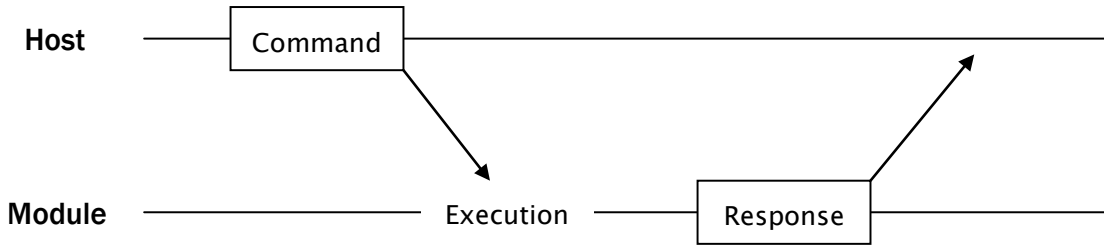

4.3.2. Irregular Operation (Communication Error)

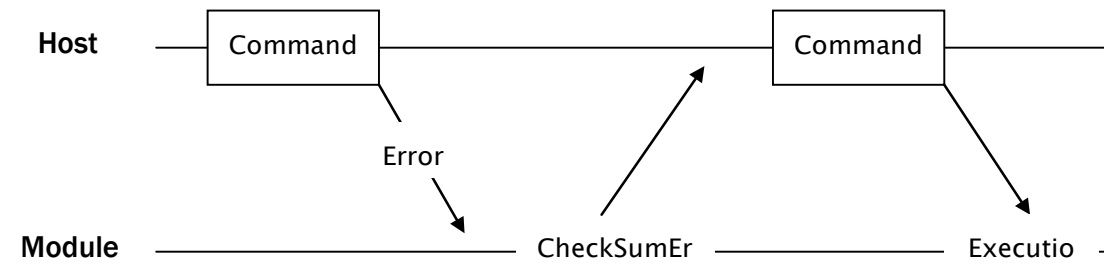
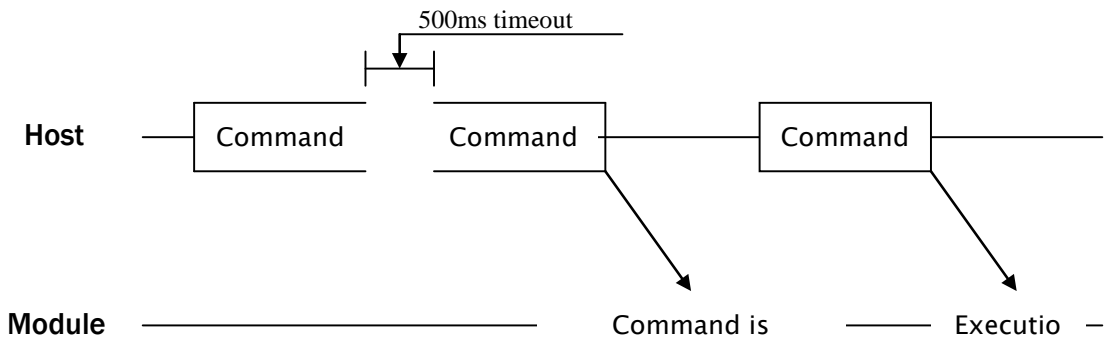

5. Using the printer

5.1. Control panel.

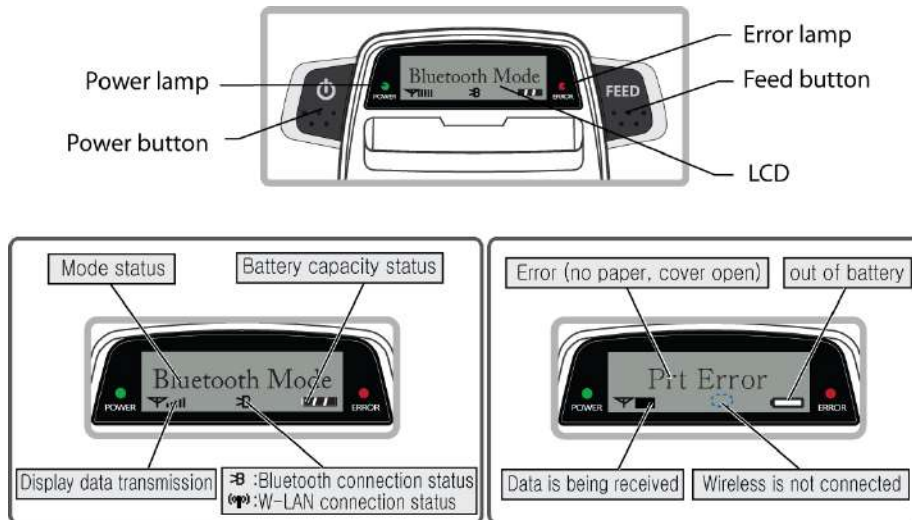

► BUTTON

- **FEED Button** : When the printer is on, paper can be feed manually by pressing and holding the FEED button for more than one second.
- **POWER Button:**
 - ① When of 5 or more seconds presses and power comes to on or off.
 - ② After pressing the POWER and the FEED button simultaneously, if the ERROR lamp 5 turn signals POWER button is converted with MODE functions.
- In keeping on pressing the **Feed and Power button** simultaneously until after the **ERROR lamp** blinks 5 times, the printer comes out at the circumstance to change the printer mode. (Refer to **2.6. Set operation mode** for details about mode conversion)

► LAMP

- **POWER lamp(GREEN)** : Printer is ON and ready to receive data.
- **ERROR lamp(RED)** : Indicated a fault condition or a printer error.
(details: no paper, paper cover opened. etc.)

► LCD

- LCD will display most of the printer status.
(details: current printer status, paper out, indicated remaining battery, Bluetooth connection etc.)

5.2. The self test

Self-Test prints out the current setting value of printer. The way of self-test is as follows.

1. Insert proper paper into the printer.
2. Power on while pressing feed button to start self-test.
3. Printer will print out the current status. (F/W version and set contents)
4. And then pattern of characters will be printed out.
5. Self-test will be finished automatically and turned to the standby status.

※ In case printer does not work properly, please contact Woosim customer service center.

5.3. Using the Accessory

5.3.1. Using the Shoulder strap

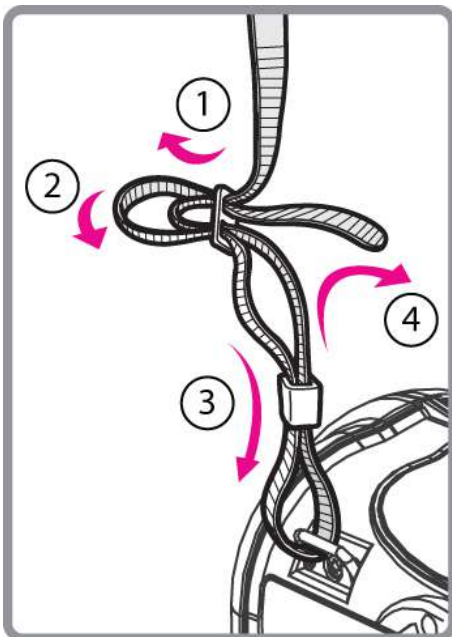

Please sling it over your shoulder after fixing the shoulder strap to the printer in the order of the illustration.

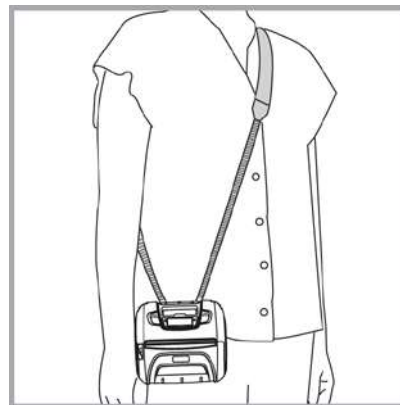

5.3.2. Using the Belt clip

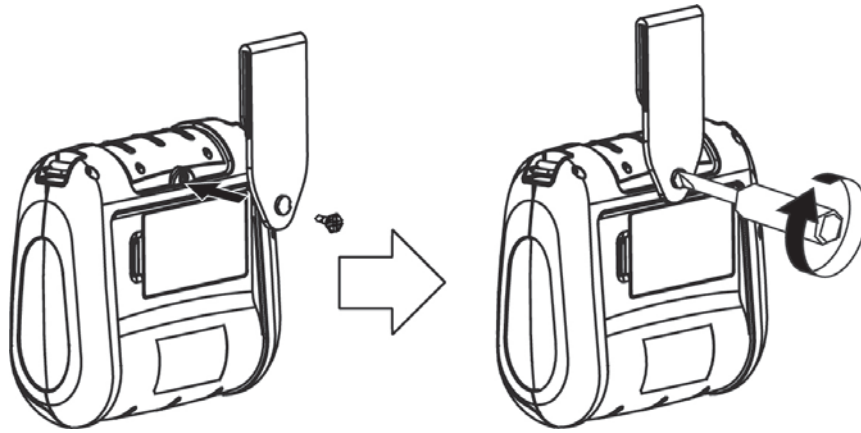

Following the instruction of the arrow, please put the belt clip in the hole and turn and fix the screw to the right by using a screw driver.

Afterward, you can use it like the picture below.

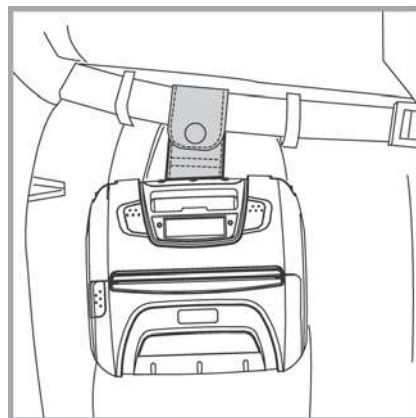

6. Consumable Parts.

6.1. Recommended paper.

Type	: Thermal Paper
Paper width	: 113mm
Paper thickness	: $60 \pm 5 \mu\text{m}$
Outer diameter	: $\text{Ø}50\text{mm}$ or less
Recording side	: Outside of roll



Cautions

1. Do not paste the paper to the core. And the roll paper which has Near end mark printing on its near end is recommended.
2. Chemicals or oil may change the color of paper, or printed Characters may fade.
3. Change of paper color starts from approx 70 °C.
Pay attention to heat, humidity and sun light.
4. Color of paper may be changed by being scratched by nail or hard metal, etc

6.2. Printing position.

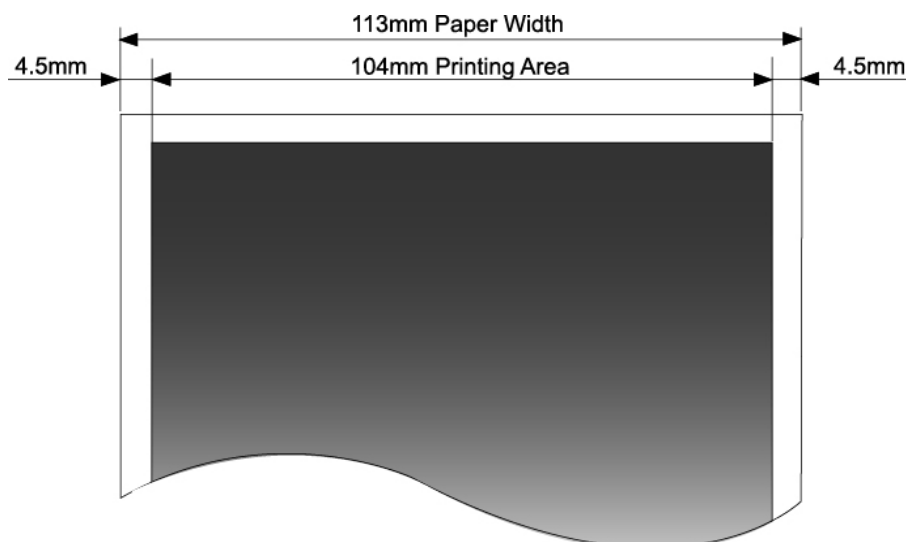

7. Revision History

Date	Version	Comments
Dec. 24. 2010	2.0	2.2 Part Name additional (Sensor)
Feb 17. 2011	3.0	2.6.1 GAP/HOLE SENSOR SETTING additional
Aug. 10. 2012	4.0	* 4inch Industrial Printer → Rugged mobile printer P3 : ► Agency Approvals of the image update p17 : Bluetooth Mode or Bluetooth(iAP) Mode setting addition
Oct. 18. 2012	5.0	p3 : ► High speed(80 -> 110mm/sec , MAX) : p9 same ► Free fall : 1.5 -> 2M drop resistance P9 : Barcode contents update p11 : Printer accessories modify p16 : Recharging the battery image update p17 : Set operation mode modify
Aug. 07. 2013	6.0	p9 : Specifications modify p12-14 : Part name, Dimension modify (MSR Part addition) p19-22 : Set operation mode modify p20 : 2.6.1 GAP/HOLE Sensor Setting modify
Oct. 21. 2014	6.1	p3 : ► Free fall : 2 -> 1.8M p3,9,25 : WLAN spec. update p19-21 : Set operation mode method modify p24 : UART Pin spec modify Add contents of the note
Mar. 11. 2016	6.2	p3 : Weight modify p3,9,13,14 : Dimensions modify p3,9,25 : Bluetooth spec. update
Oct. 05. 2016	6.3	p3 : Agency Approval symbol modify p5 : 1.2 Symbol add p8 : CE warning add p17 : battery warning add p29 : LCD image update p31 : Belt clip setup image update
May. 12. 2017	6.4	Change page layout (B5→A4) * Delete address
Feb. 12. 2020	6.5	p11 : Battery capacity update (2,200mAh→2,550mAh) Environment conditions update p11,12 : Battery charger update (SHE)



WSP-i450

Türkiye Genel Dağıtım:
Uting Elektronik ve Endüstriyel Ürünler, Mümessillik,
Dış Ticaret ve San. Ltd.Şti.
Adres: Çobançeşme, Gençosman Sokak no:10
34196 Yenibosna - İSTANBUL
www.utingelektronik.com
Tel: 0212- 639 20 95 Fax: 02120 639 32 19

Üretici Firma:

WOOSIM SYSTEMS INC.
#60, Sandan-ro 388 beon-gil, Galsan Myeon,
Hongseong-gun, Chungcheongnam-do
32200 S.Korea
Tel: +82 41 339 3700
Fax: +82 41 339 3701